

ZD 9 DOOR HANDLE



On longitudinal clip plate

- Application: for **private living area**, e.g. room, bath and apartment entrance door
- **Material: die-cast zinc**
- Bearings: Plastic bearings in long plate on both sides
- Fastening: Covered laying on one side with particle board screws

Technical information:

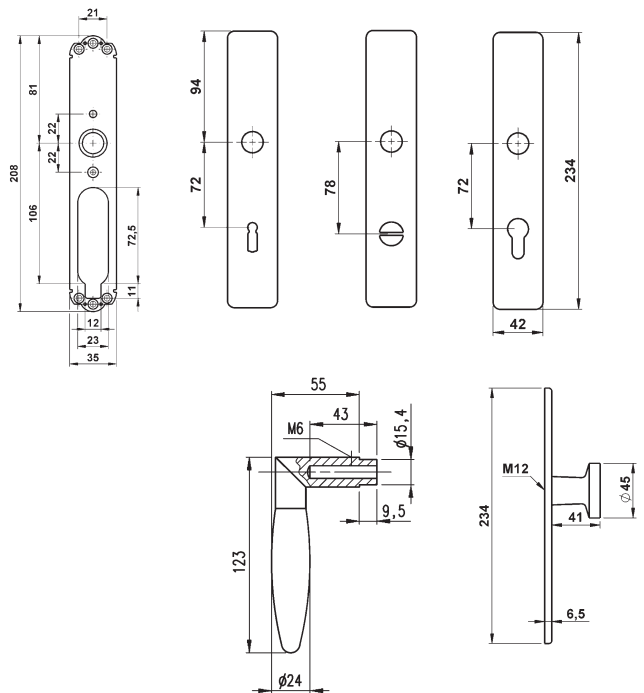

With the door handle pairs, square pin ■ 8 mm is always located on one side securely in the door handle

Door handle surface: matt nickel-plated/chrome-plated Long plate surface: matt nickel-plated

Designation	Suitable for door thicknesses from – to in mm	■ in mm	Art. No.	The following sets must be put together from:					P. Qty.	
				KH set	WC/bath set	PC set	Change DIN R+ DIN L Doors	Demo Set		
ZD9 door handle pair	38 – 42	8	0687 170 009	X	X	X			1/10	
Long plate pair with KH perforation			0687 170 090	X				X		
Long plate pair with bathroom locking olive			0687 170 091		X					
Long plate pair with PC perforation			0687 170 092				X			
Changing set without handle perforated part			0687 170 093					X		
ZD9 door handle perforated part			0687 170 709					X		X

1 P. Qty. must be combined.

Installation accessories: 3 mm offset screwdriver, particle board screw, 3.5 x 15 mm galv., special grub screw, M6 x 6 galv.

Specified dimensions not binding. Subject to technical changes!