

## System workshop trolley Basic 8.8

**Spacious workshop trolley in a unique design which can be equipped with all foam and tray inserts as well as system boxes of the ORSY system thanks to the system dimensions.**

### Two-stage locking concept

- Central locking with cylinder lock
- One-handed unlocking and individual drawer locks prevent drawers opening by themselves

### Comfortable movement of the trolley

Stable side handle

### Wide range of accessories

The workshop trolley can be adjusted to any needs through different accessories.

### Drawers with full extension

Width x depth x height (external dimension)	880 x 520 x 985 mm
Number of rolls	4 PCS
Design of the rolls	1 swivel castor with brake (D: 125 mm), 1 swivel castor without brake (D: 125 mm), 2 fixed castors without brake (D: 125 mm)
Surface	Powder-coated
Material	Sheet steel
Pullout type	Full extension, Ball-bearing
Load capacity	300 kg
Load capacity of drawer	35 kg

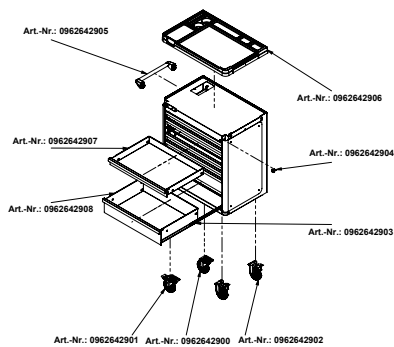

Illustration only



Type description	Drawer design	Colour	Number of drawers	Art. No.	P. Qty.
BASIC 8.8/6	3 drawers, W 674 x D 463 x H 71 mm, 3 drawers, W 674 x D 463 x H 156 mm	Traffic red RAL 3020	6 PCS	<b>0962 642 060</b>	1
BASIC 8.8/7	5 drawers W 674 x D 463 x H 71 mm, 2 drawers, W 674 x D 463 x H 156 mm	Traffic red RAL 3020	7 PCS	<b>0962 642 070</b>	1
BASIC 8.8/8	7 drawers, W 674 x D 463 x H 71 mm, 1 drawer W 674 x D 463 x H 156 mm	Traffic red RAL 3020	8 PCS	<b>0962 642 080</b>	1
BASIC 8.8/6	3 drawers, W 674 x D 463 x H 71 mm, 3 drawers, W 674 x D 463 x H 156 mm	Gentian blue RAL 5010	6 PCS	<b>0962 642 061</b>	1
BASIC 8.8/7	5 drawers W 674 x D 463 x H 71 mm, 2 drawers, W 674 x D 463 x H 156 mm	Gentian blue RAL 5010	7 PCS	<b>0962 642 071</b>	1

Type description	Drawer design	Colour	Number of drawers	Art. No.	P. Qty.
BASIC 8.8/8	7 drawers, W 674 x D 463 x H 71 mm, 1 drawer W 674 x D 463 x H 156 mm	Gentian blue RAL 5010	8 PCS	<b>0962 642 081</b>	1
BASIC 8.8/6	3 drawers, W 674 x D 463 x H 71 mm, 3 drawers, W 674 x D 463 x H 156 mm	Telegrey 4 RAL 7047	6 PCS	<b>0962 642 062</b>	1
BASIC 8.8/7	5 drawers W 674 x D 463 x H 71 mm, 2 drawers, W 674 x D 463 x H 156 mm	Telegrey 4 RAL 7047	7 PCS	<b>0962 642 072</b>	1
BASIC 8.8/8	7 drawers, W 674 x D 463 x H 71 mm, 1 drawer W 674 x D 463 x H 156 mm	Telegrey 4 RAL 7047	8 PCS	<b>0962 642 082</b>	1
BASIC 8.8/6	3 drawers, W 674 x D 463 x H 71 mm, 3 drawers, W 674 x D 463 x H 156 mm	Traffic black RAL 9017	6 PCS	<b>0962 642 063</b>	1
BASIC 8.8/7	5 drawers W 674 x D 463 x H 71 mm, 2 drawers, W 674 x D 463 x H 156 mm	Traffic black RAL 9017	7 PCS	<b>0962 642 073</b>	1
BASIC 8.8/8	7 drawers, W 674 x D 463 x H 71 mm, 1 drawer W 674 x D 463 x H 156 mm	Traffic black RAL 9017	8 PCS	<b>0962 642 083</b>	1

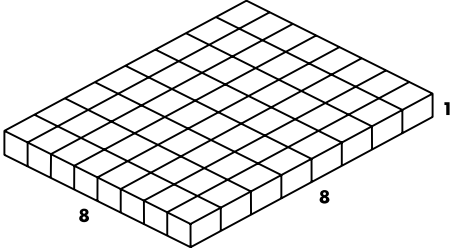
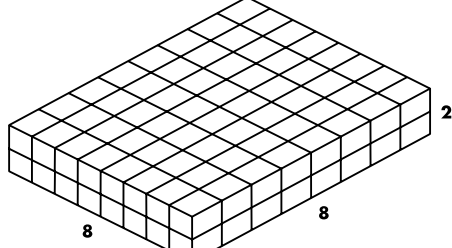
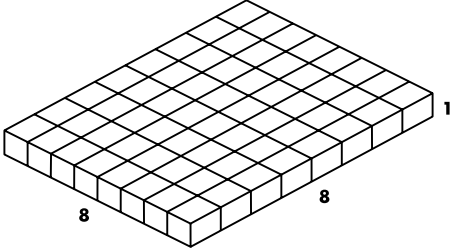
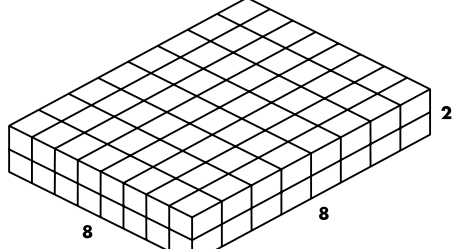

System grid dimensions for drawers		
Art. no.	Drawer	Grid dimensions
0962 642 060 to 0962 642 063	1-3	 <p>8.8.1</p>
	4-6	 <p>8.8.2</p>
0962 642 070 to 0962 642 073	1-5	 <p>8.8.1</p>
	6-7	 <p>8.8.2</p>

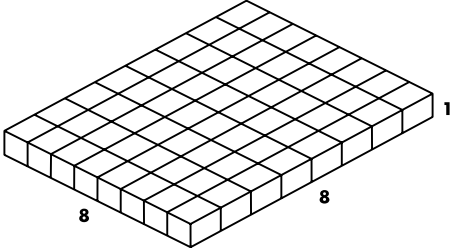
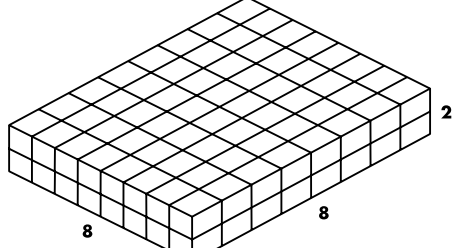
System grid dimensions for drawers		
Art. no.	Drawer	Grid dimensions
0962 642 080 to 0962 642 083	1-7	 <p>8.8.1</p>
	8	 <p>8.8.2</p>

## Details/Application



Central locking



One-handed unlocking and individual drawer locking



Compatible with the tool assortments as well as small part assortments and system boxes



Hanging rails for ORSY system boxes



Wheels produced from trackless rubber



Sturdy side handle

## Details/Application



Can be personalised with name plate

Plastic top with pen tray, can holders and large curves for simple removal of small parts

Spare parts	Art. No.
Steering roller with brake	0962 642 900
Steering roller without brake	0962 642 901
Fixed castor	0962 642 902
Extendable drawer	0962 642 903
Lock	0962 642 904
Handle	0962 642 905
Deep-drawn top	0962 642 906
Drawer	0962 642 907
Large drawer	0962 642 908